

# Smappee EV Wall

Installation manual

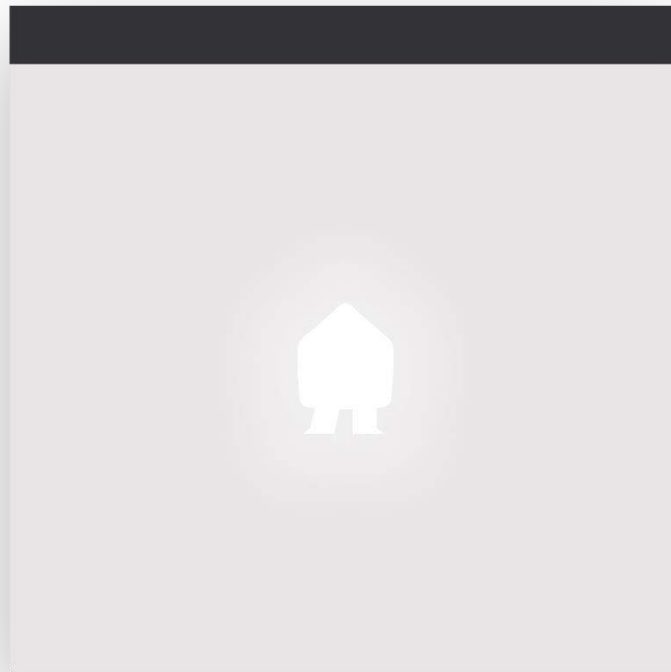

# Table of contents

1. Introduction .....	3
2. Safety instructions.....	4
3. Models .....	6
4. Components.....	7
5. Technical specifications.....	10
6. Preparing the installation .....	11
7. Installation and activation .....	14
8. Using the EV Wall .....	26
9. Declaration of conformity .....	30

# 1. Introduction

Thank you for purchasing this Smappee EV Wall charging station for electric vehicles, the smartest charging station for charging at home.

This installation and user manual tells you how to install and use the Smappee EV Wall. We advise you to read the contents of this manual carefully, to ensure a safe and proper installation and enable you to use all the advanced features of this product to their full extent.

## Support

Only qualified electricians or equivalent may install the Smappee EV Wall. If you have any questions, please contact your service partner.

Please have the following information ready to hand to speed up the process: Article number and serial number which you can find on the identification label of the charging station.



Should your local distributor be unable to help you, or you have a suggestion for us, you can contact Smappee at: **support@smappee.com**.

Smappee n.v.  
Evolis 104  
8530 Harelbeke  
Belgium

## 2. Safety instructions



### Safety warning

Fully read and follow the safety instructions below before you install, service or use your Smappee EV Wall. The installer must ensure that the charging station is installed in accordance with the relevant national and local regulations.

Carrying out activities on this charging station without the relevant knowledge and qualifications can lead to serious accidents and death. Only carry out tasks for which you are qualified and have been fully instructed.

Incorrect installation, repairs or modifications can result in danger to the user and may void the warranty and liability.

### Safety precautions

	<b>CAUTION:</b> Risk of electric shock.
	<b>CAUTION:</b> Refer to the accompanying documentation whenever you see this symbol.

Please observe the following safety precautions to avoid potential electric shock, fire, or personal injury:

- Use this charging station only for its intended purpose.
- Switch off electrical power supply to your charging station before installation or maintenance work.
- Do not use the charging station if damaged / defective.
- Do not immerse the charging station in water or any other liquids.
- Do not expose the charging station to heat, flame or extreme cold.
- Do not attempt to open, repair, or service any parts. Contact Smappee or your service partner for further information.
- Only use the charging station under the specified operating conditions.
- Do not allow children to operate a charging station.
- When a charging station is in use, adult supervision of any children present is required.
- While charging the charging cable must be completely unwound and connected to the electric car without overlapping loops. This to avoid the risk of overheating the charging cable.

### Maintenance

- Observe the maintenance schedule.
- Clean the outside only with a dry, clean cloth.
- Do not use abrasive agents or solvents.

## Keeping order

- After charging, store the charging cable properly so it does not present a tripping hazard.
- Make sure the charging cable cannot become damaged (kinked, compressed or driven over).
- Do not place any objects on the charging station.

## Transport and storage

- Disconnect electrical power supply before removing the charging station for storage or relocation.
- Only transport and store the charging station in its original packaging. No liability for damage incurred will be accepted if the charging station is transported in non-standard packaging.
- Store the charging station in a dry environment within the temperature range specified in the technical specifications.

### 3. Models

Article no.	EAN	Description
EVW-132-BR-E-W	5425036931916	EV Wall 1-Phase 7.4kW Socket Right White
EVW-132-BR-E-B	5425036931923	EV Wall 1-Phase 7.4kW Socket Right Black
EVW-132-C2R-E-W	5425036931954	EV Wall 1-Phase 7.4kW Type 2 cable 2,5m Right White
EVW-132-C2R-E-B	5425036931961	EV Wall 1-Phase 7.4kW Type 2 cable 2,5m Right Black
EVW-132-C8R-E-W	5425036931992	EV Wall 1-Phase 7.4kW Type 2 cable 8m Right White
EVW-132-C8R-E-B	5425036932005	EV Wall 1-Phase 7.4kW Type 2 cable 8m Right Black
EVW-332-BR-E-W	5425036932036	EV Wall 3-Phase 22 kW Socket Right White
EVW-332-BR-E-B	5425036932043	EV Wall 3-Phase 22 kW Socket Right Black
EVW-332-C2R-E-W	5425036932074	EV Wall 3-Phase 22 kW Type 2 cable 2,5m Right White
EVW-332-C2R-E-B	5425036932081	EV Wall 3-Phase 22 kW Type 2 cable 2,5m Right Black
EVW-332-C8R-E-W	5425036932111	EV Wall 3-Phase 22 kW Type 2 cable 8m Right White
EVW-332-C8R-E-B	5425036932128	EV Wall 3-Phase 22 kW Type 2 cable 8m Right Black

## 4. Components

### Components included

Single phase



EV Wall

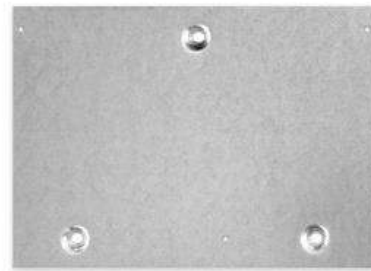

EV Wall mounting plate



EV Wall splitter



DIN mounting plate



Connect



Wall mounting plate



CT Hub



CT 50A



RJ10 cable  
40 cm



RJ10 cable  
150 cm



Bus termination plug



Screw & plug



Small screw

## Three phase

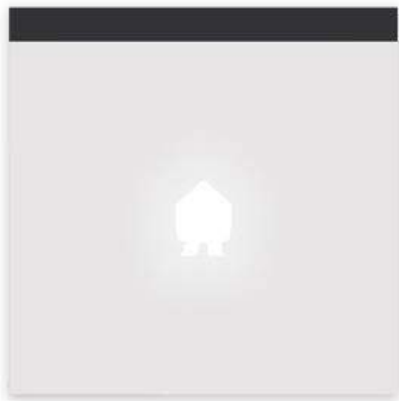

EV Wall

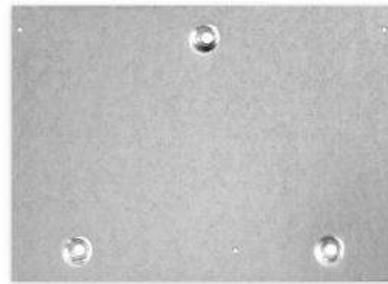

EV Wall mounting plate



EV Wall splitter



DIN mounting plate



Connect



Wall mounting plate



CT Hub



CT 50A



Solid Core  
3-phase CT



Bus termination  
plug



RJ10 cable  
40 cm



RJ10 cable  
150 cm



Screw & plug



Small screw



## Type 2 EV charging cable

In case of a fixed cable version the cable is supplied in a separate box.

1. 1 x 2.5 m or 8 m open-ended to type 2 EV charging cable
2. 8 m version: 1 x EV cable holder + 3 x screws + 3 x plugs

## Identification label

The identification label of your charging station is located on the left inside of the EV Wall.

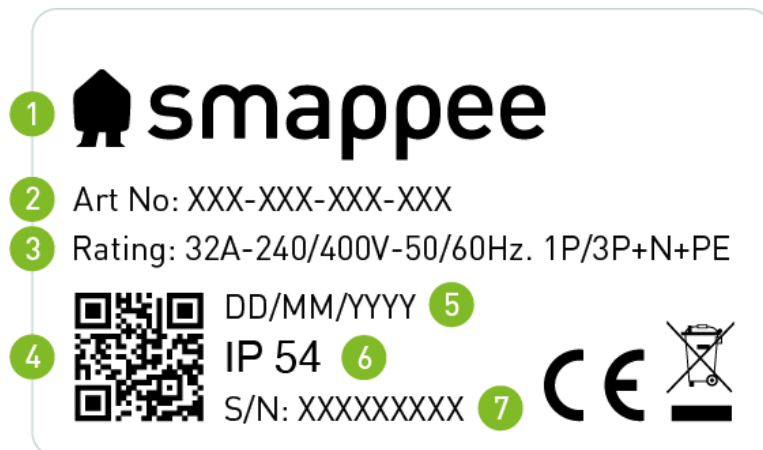

1. Manufacturer
2. Article number
3. Rating
4. QR code containing article number and serial number
5. Manufacturing date
6. Degree of protection
7. Serial number

## 5. Technical specifications

Feature	Description	
	EV Wall - Socket	EV Wall – Type 2 cable
<b>Technical features</b>		
Charging capacity	Single or triple phase, 3.7 to 22 kW	
Output power	1-phase or 3-phase, 230 V – 400 V, 32 A	
Charge mode	Mode 3 (IEC 61851)	
Connection case	1 x Case B (Socket type 2)	1 x Case C (Fixed cable with type 2 connector)
Integrated Residual Current Monitor	Rated operating residual current detection : 6 mA DC / 30 mA AC	
Metering	kWh meter compliant with IEC 62053-21	
<b>Interfaces &amp; Connectivity</b>		
Information status	RGB LED	
Session activation	Plug and charge, Scan QR code, Swipe RFID card, Smart EV schedules	
Connectivity	Ethernet 100BASE-T or Wi-Fi 2.4 GHz	
Communication protocol	OCPP 1.6 JSON	
<b>Certifications and Standards</b>		
Product certification	CE	
Standards	IEC 61851-1 (2017)	
<b>Environment</b>		
Enclosure material	Steel (housing), aluminium (front plate)	
Enclosure rating	IP54 / IK10	
Enclosure standard colours	RAL9016 (star white) + RAL7021 (black grey)	
Operating temperature	-25 °C to 60 °C	
Storage temperature	-25 °C to 80 °C	
Relative humidity	0 % - 95 %, non-condensing	
Maximum installation altitude	0 – 2.000 m	
<b>Physical properties</b>		
Dimensions	300 x 300 x 110 mm	
Weight (excluding packaging)	6.2 kg	6.8 kg (2.5 m cable) or 9.8 kg (8 m cable)
Charging cable length	N/A	1 x 2.5 m or 1 x 8 m
Mounting method	Wall	

## 6. Preparing the installation

The first step is to prepare the physical installation of the EV Wall as described in this chapter.

### Installation prerequisites

- Calculate the existing electrical load to find the maximum operating current for the charging station installation. The Smappee EV Wall is equipped with 1 connector (socket or fixed cable) which needs to be powered.
- Determine the voltage drop over the distance from the power supply panel to the charging station installation. The voltage drop must not exceed 5 %. It is advised that the maximum voltage drop be 3 %. The maximum wire gauge that can be fitted is 10 mm<sup>2</sup>. Local regulations may be applicable and can vary depending upon the region or country.
- Obtain all necessary permits from the relevant local authority.
- Refer to local wiring regulations to select the conductor sizes and use only copper conductors.
- Make sure that the installation area of the charging station is adequate for usability and ventilation purposes.
- Use the correct tools and provide sufficient material resources and protection measures.

### Route power supply

- The appropriate wire gauge of the supply cable depends on the power rating and distance between the meter cabinet and the charging station. The voltage drop must not exceed 5%. It is advisable to have a maximum voltage drop of 3%. The maximum wire gauge that can be fitted is 10 mm<sup>2</sup>.
- Route the power supply cables to the position where the charging station will be installed together with a Cat 5/6 communication cable between the EV Wall and distribution panel.
- Make sure that there is at least 30 cm cable available at the location of the EV Wall to be able to connect it easily internally.

	The power supply enters the station at the bottom of the housing.
	The Cat 5/6 communication cable also enters the charging station via the floor plate. Ensure that you attach the RJ-45 connector only <b>after</b> inserting the cable into the EV Wall housing.

The maximum power rating for each connector is specified in the table below.

Power per connector	Connection	Input current	Output current
3.7 kW	1-phase	1 x 16 A	1 x 16 A
11 kW	3-phase	3 x 16 A	3 x 16 A
22 kW	3-phase	3 x 32 A	3 x 32 A

## Route communication cable

The EV Wall requires a communication cable between the EV Wall and the distribution panel where the CT measurements and Connect gateway are placed. To do this, two twisted pairs of a Cat 5 or Cat 6 networking cable are used. The Cat 5/6 cable should be connected between the PCB of the EV Wall's front plate and the splitter in the distribution panel. An RJ-45 connector (not supplied) should be attached to both ends of the cable. Only attach the RJ-45 connector **after** inserting the cable into the housing. The RJ-45 connector will not fit through the EV Wall's cable gland!

## Prepare the mounting

All Smappee EV Wall types are designed to be mounted on a wall.

When positioning the EV Wall, take into account that the power supply cables and communication cable are entering the housing at the bottom through cable glands. The central M32 cable gland is for the power supply, the M20 cable gland for the communication cable.

### Tools (not included)

- Screwdrivers
- 3mm Hex screwdriver
- 7mm socket wrench with extension bar
- Multimeter and earth ground meter
- Wire stripper and cutter.
- Needle-nose pliers.
- Ferrules crimper, for stranded power supply cables
- Drill and rock drill diameter 10 mm.
- Hammer
- RJ45 crimping tool

### Supplies (included)

- 3 x wall plugs and screws anchors ( $\varnothing$  6 mm x 50 mm)
- 3 x M4 x 6 mm HEX screws

### Supplies (not included)

- CAT 5/6 cable and two RJ45 connectors for wired communication cable.
- Power supply cables
- Ferrules (10 mm<sup>2</sup>), for stranded power supply cables
- 32 A circuit breaker

## 7. Installation and activation

This procedure describes the required steps for the physical installation of the EV Wall.



**CAUTION:** Make sure it is not possible to connect the electric current during installation. Put up caution tape and warning signs to mark the work areas. Make sure no unauthorised people can enter the work areas.

### Place the mounting plate in position

- a. Use the mounting plate to mark the position of the screws on the wall where the EV Wall is to be positioned. Make sure the mounting plate is positioned with the 2 insert holes on the bottom, as depicted below.

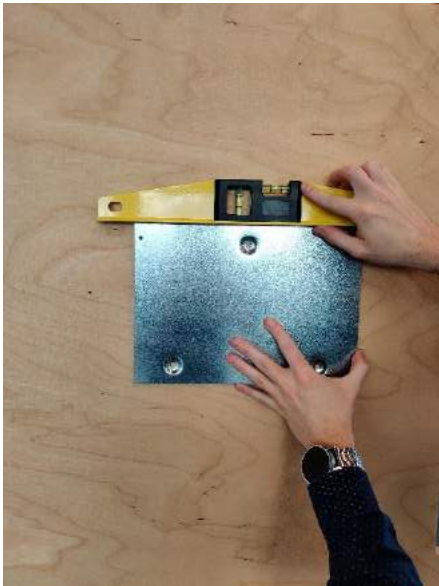

- b. Drill 3 holes of 10 mm diameter through the slots to a depth of 50 mm. Insert the supplied wall plugs into the holes.



- c. Attach the mounting plate to the wall with the supplied screws.

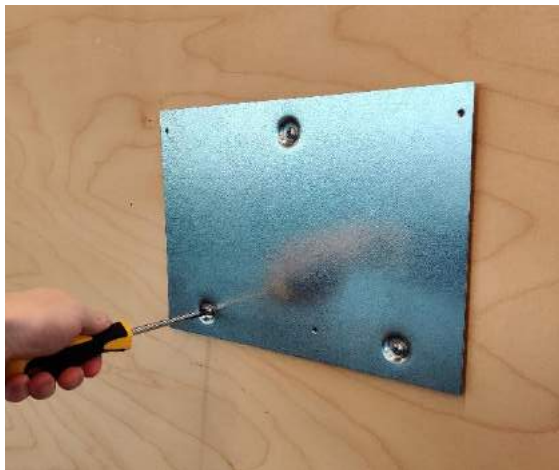

## Place the EV Wall in position

- a. Remove the front plate of the EV Wall and disconnect the communication cables. Safely put aside the front plate to avoid damaging the PCB-board attached to it.

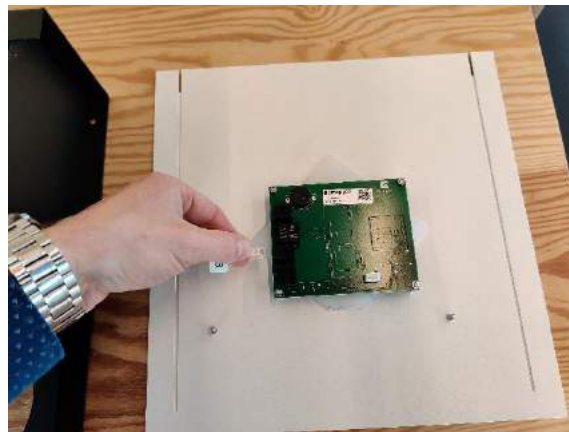
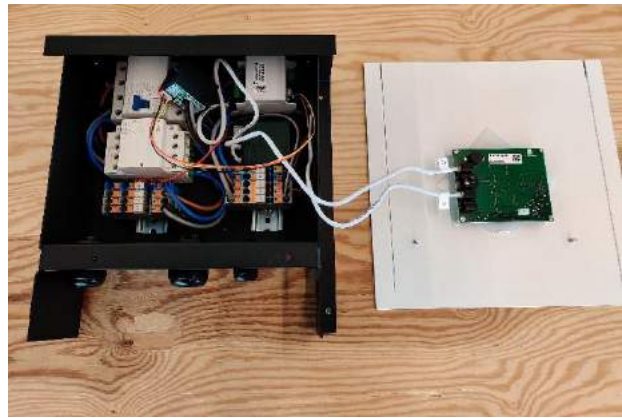
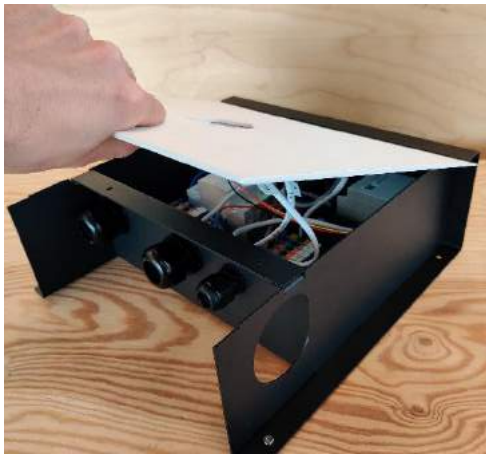

- b. Attach the EV Wall housing to the mounting plate using the three supplied M4 x 6 mm HEX screws.

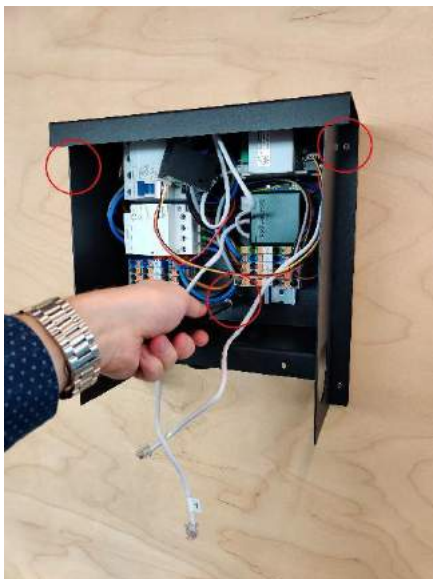



## Power supply connection

- a. Slide the power cable through the middle cable gland.

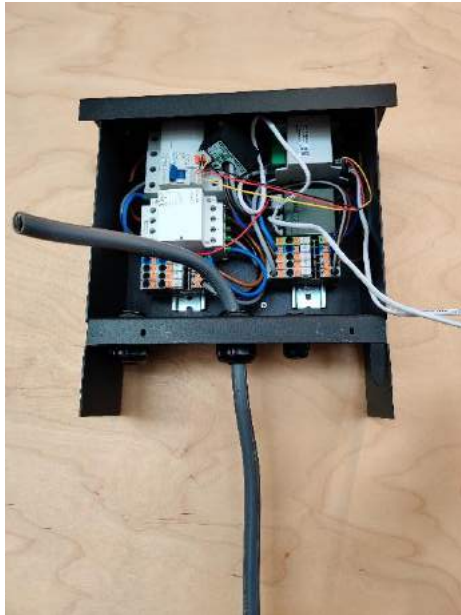

- b. Cut the power supply cables to adequate length and add the ferrules to each conductor if stranded cables are used.
- c. Measure the resistance of the grounding circuit and make sure that it is within acceptable limits. If necessary, install a grounding point closer to the charging station.
- d. Connect each supply cable to the terminal block.

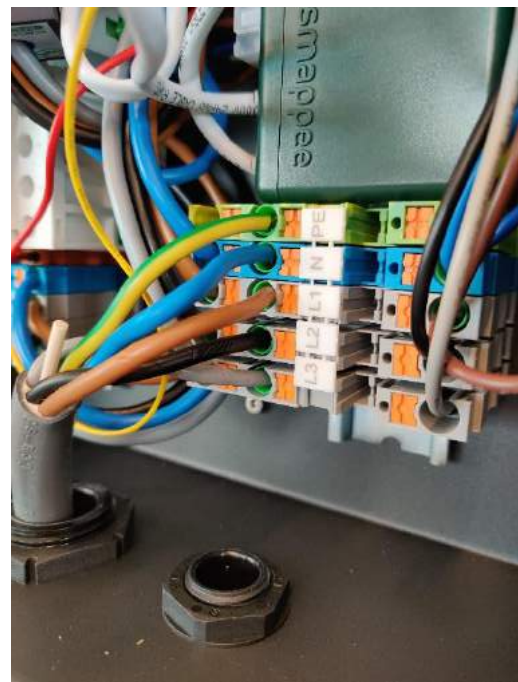
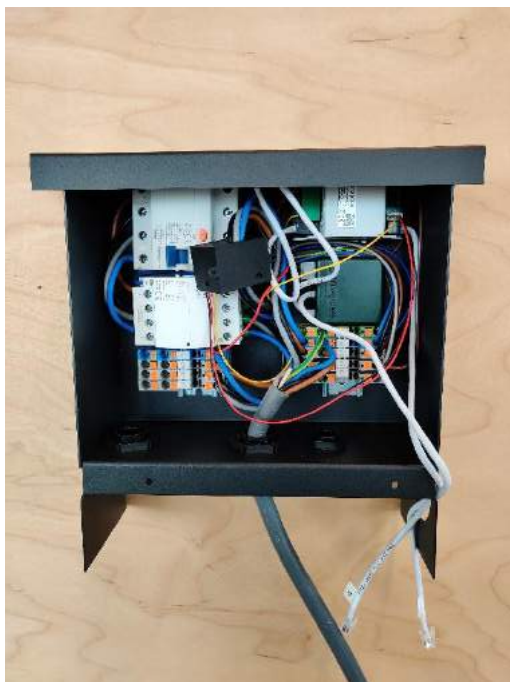

## EV charging cable mounting (only fixed cable version)



This section is only relevant if the EV Wall comes with a fixed cable. If you have a socket version, please continue to the next section.

- a. Mount the fixed charging cable through the left M32 cable gland and mount the power supply wires to the terminal block. Do not forget to connect the small orange CP data cable.

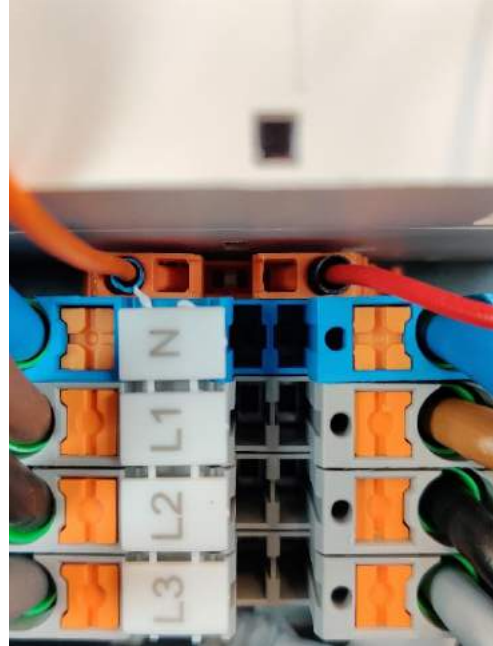
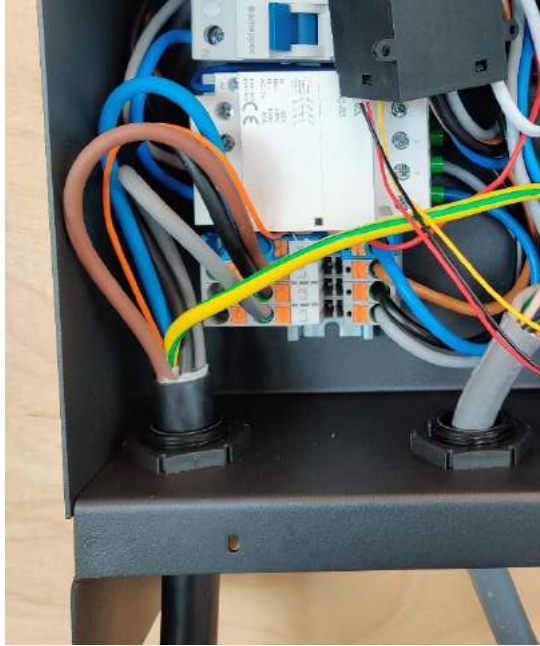

- b. For the 8 m version, a separate cable holder is supplied and can be mounted on the wall nearby the EV Wall.



The length of the fixed cable can be shortened if required. Cut the cable to its required length and add ferrules (not supplied).

## Installation in distribution panel

This chapter describes the installation of the Infinity components in the distribution panel. These components enable overload protection & solar optimization supplied with the EV Wall.

The EV Wall package comes with the required Smappee Infinity components to be installed in the distribution panel to measure the main feeder (total grid consumption) and single-phase solar production. If three-phase solar is present, the EV Wall Solar Add-on can be purchased.

Depending on the EV Wall type (1-phase or 3-phase), the included Smappee Infinity components varies:

- EV Wall 1-Phase:
  - 1 x Connect
  - 1 x CT Hub
  - 3 x CT 50A (1x grid + 1x solar +1x EV measurement)
  - 1 x EV Wall splitter
- EV Wall 3-Phase:
  - 1 x Connect
  - 1 x CT Hub
  - 4 x CT 50A (3x grid + 1x solar measurement)
  - 1 x Solid Core 3-Phase CT (EV measurement)
  - 1 x EV Wall splitter



If additional CT measurements need to be added, standard Infinity hardware (CT Hubs and CTs) can be purchased and installed in addition to the EV Wall components. Always keep the Smappee Infinity installation guidelines in mind.

For installation of these components, please refer to the diagrams on the next page.

The main installation steps include:

- a. Install the 32 A circuit breaker (not supplied) according to local regulations. In case of a three-phase EV Wall: install the supplied solid-core CT together with the circuit breaker.
- b. Install the CTs as indicated on the diagrams on the next page. Connect these to the supplied CT Hub.
- c. Install the Smappee Connect and EV Wall splitter. The Smappee Connect should be placed inside or near the distribution panel. It requires a stable internet connection via Wi-Fi or Ethernet.
- d. Connect the A- and B-bus cables as indicated on the diagram. Connect the Cat 5/6 communication cable to the RJ45 port of the splitter.



Ensure that the CT Hub(s) are connected to the A-port of the Smappee EV Wall splitter and the Smappee Connect to the B-port of the Splitter. Also check that the Cat 5/6 communication cable is connected to the splitter and NOT to the Smappee Connect.

## Connection diagram EV Wall – 1-phase (1P+N)

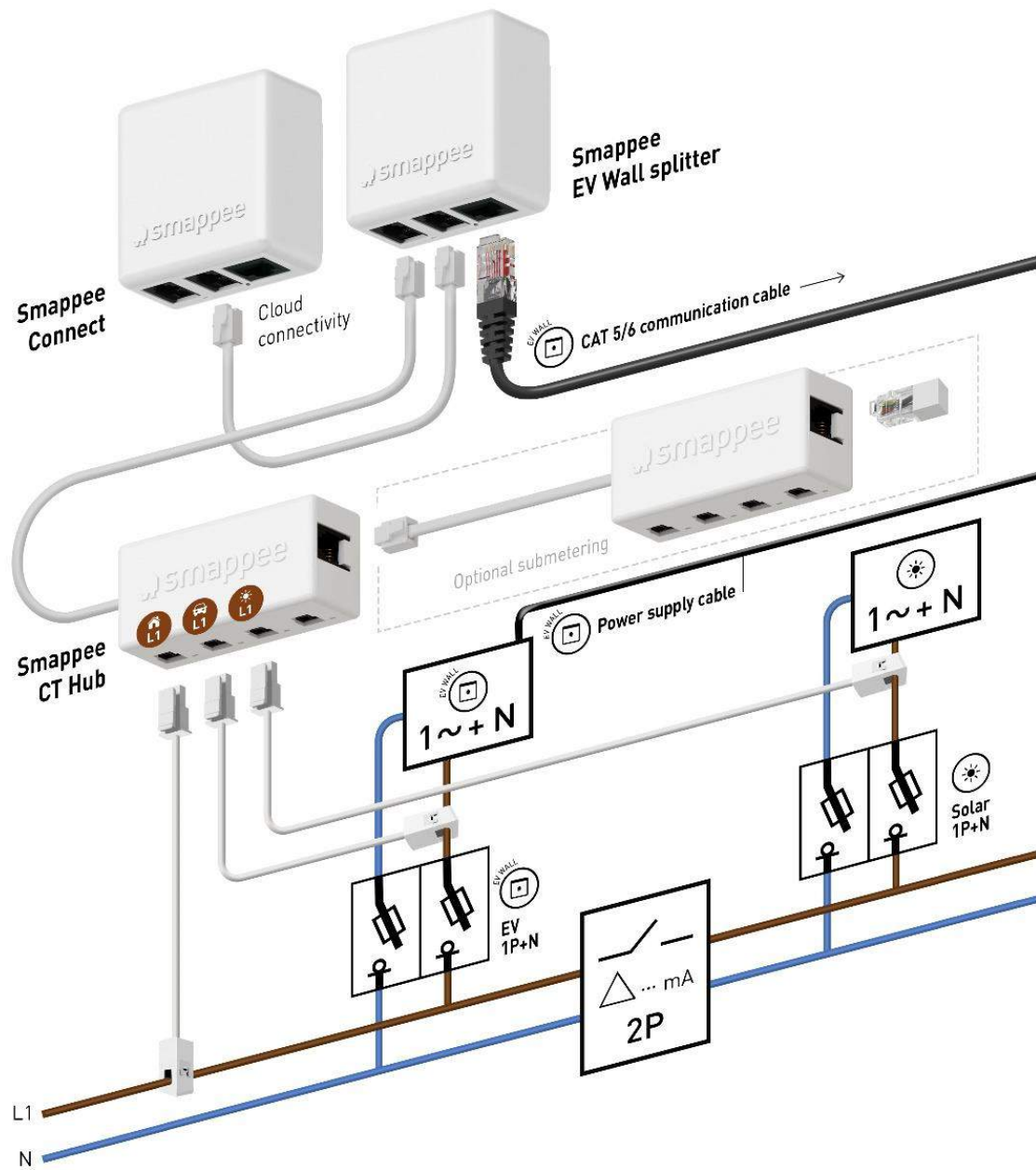

## Connection diagram EV Wall – 3-phase (3P+N)

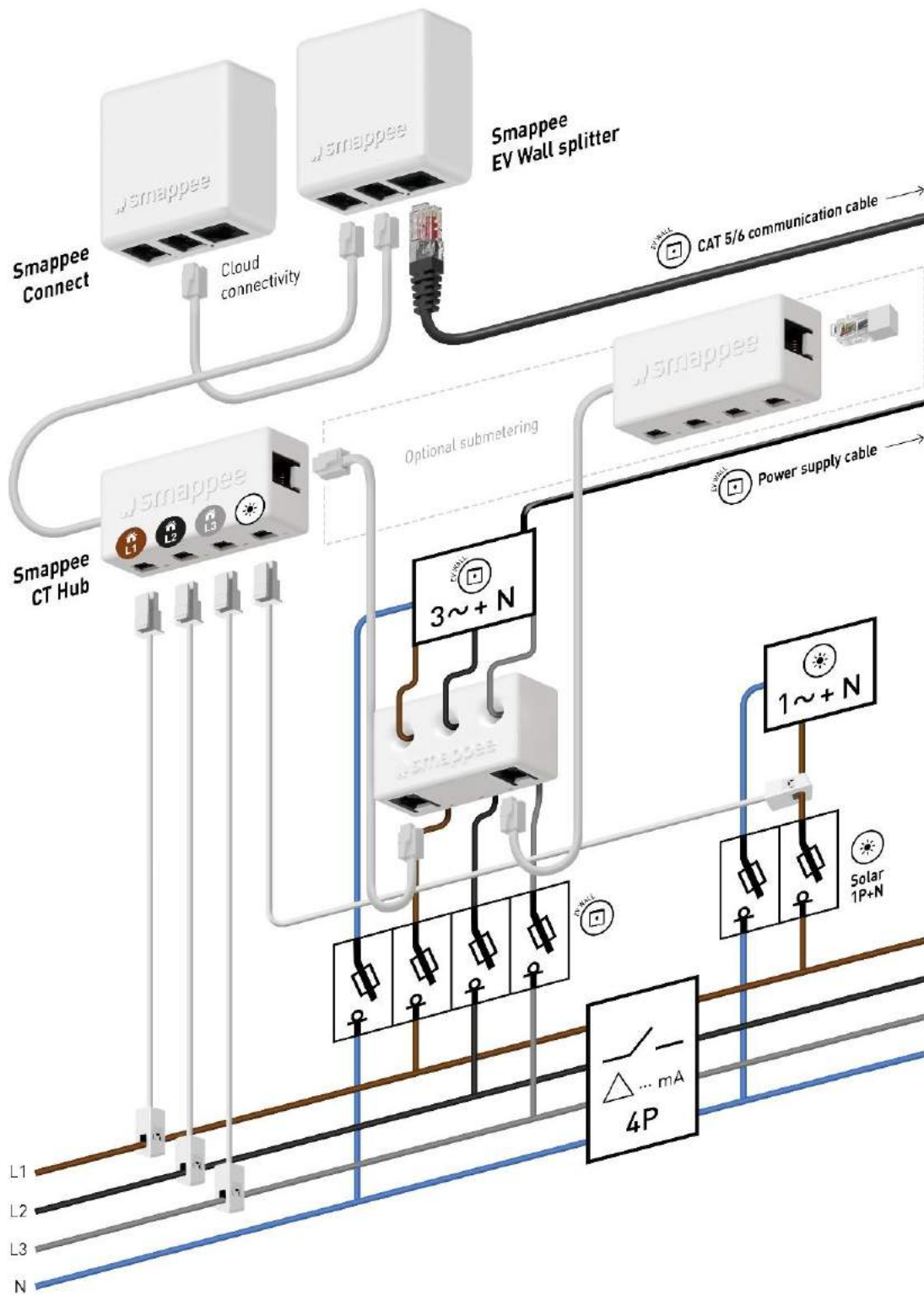



## IMPORTANT notes for 3P (3\*230V) – Delta topology

When an EV Wall is installed in a residential installation with a 3P (3\*230V) – Delta grid connection, some additional requirements need to be taken into account. These guidelines have nothing to do with the Smappee EV Wall architecture but linked to how the utility provides the grid connection to the home.

Some EV-vehicles are not compatible with 3P (3\*230V) grid connection due to a built-in security in the EV. Contact your EV manufacturer for more information.

### Context

There are 2 types of Delta connections that the grid operator can use in the low voltage cabinets and is linked to type of transformer used there.

- **Delta - Type 1:** One of the phases in the low voltage cabin is connected to earth. The voltage between ground & 1 of the phases is 0 volts.
- **Delta - Type 2:** None of the phases are connected to earth. The voltage between each phase and earth is 130V.

The security feature that some EVs have is a voltage check the EV does between the phase that is connected as neutral and the ground. If this is not 0 volts, the car won't charge. The presence of this security feature may vary for each manufacturer and for each model.

### Guidelines

With these guidelines, you are able to determine what you need to do to make sure the EV Wall can be charged.

Check prior to the EV Wall installation the type of Delta Topology by measuring the voltage between the phases and ground.

- **If 0 Volts => Type 1:** all EV cars can charge using two phases. The phase that provides 0V needs to be connected to the Neutral of the EV Wall power supply.
- **If 130V Volts (not 0V) => Type 2:** if a specific EV is to be charged, check with the EV manufacturer whether it is compatible with this setup. If a specific EV is not compatible or multiple EV-types need to be charged, **an isolation transformer needs to be installed.** In this case, an additional Smappee Power Box should be purchased and installed in the distribution panel. The Smappee Power Box in the EV Wall should be disconnected by disconnecting both the A- and B-bus cables. In the distribution panel, the A port of the splitter should not be used. The extra Power Box's A-bus should connect to the CT Hub(s) and the B-bus to the Smappee Connect, as in a standard Infinity installation.



A 3P (3\*230V) Delta topology of type 2 requires the purchase of an additional Smappee Power box which will be placed inside the distribution panel. In this case, the Power Box inside the EV Wall becomes redundant and both RJ10 cables should be disconnected.

## Closure

- a. Mount the front plate into position by connecting the RJ10 cables and Cat 5/6 cable to the PCB attached to the front plate. Pay attention to stickers and connect each cable to the corresponding input.

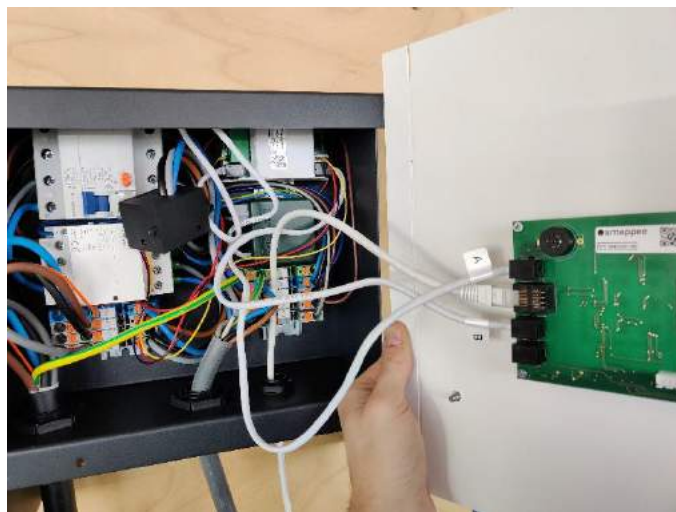

	Be careful to connect the RJ10 cables to their corresponding input. Do not connect a cable marked 'A' to an input marked 'B' and vice-versa.
	In case of a 3P (3*230V) Delta topology of type 2 (see special notes on previous page), only the B cable should be connected.

- b. Mount and tighten the supplied M4 nuts



## Switching on the EV Wall



All communication cables must be attached to the front panel before powering the EV Wall. The EV Wall should also be closed.

- a. Check all connections are secure and power-up the EV Wall.
- b. Check the status LEDs:
  - a. Charging controller: green flashing light (1 x per 3 seconds)
  - b. RCM: continuous green light
  - c. Power Box: green flashing light (1 x per 3 seconds)



## Activation

This procedure is done with the Smappee Energy Monitor mobile app. You can download this from the Apple App Store for iOS or the Google Play store for Android phones.



The Smappee App will guide you through the various steps to fill in all the required information.

- Log in to the Smappee App with the given Smappee username or create a new user account.
- Install a Smappee car charging station.
- Follow the steps shown in the mobile app.

	<p>The settings of your charging station can be adjusted in the Smappee Mobile app or Dashboard.</p> <ul style="list-style-type: none"><li>• Smappee Mobile App: Name, Minimum and maximum current per connector, Charging speed per connector and LED brightness</li><li>• Dashboard: Name, Minimum and Maximum current per connector, Phase assignment per connector, Charging speed per connector and LED brightness</li></ul>
---	---

## 8. Using the EV Wall

There are three ways of charging using a Smappee EV Wall:

1. Plug and charge: Simply connect your cable and start charging.
2. Swipe and charge: Connect the cable, swipe your card and start charging.
3. Scan and charge: Connect the cable, scan the QR code in the Smappee app and start charging.

Below you can find the different charging sequences.

	Each EV Wall that is installed and activated is Plug and charge. Changing the Session Activation Method is done using the Smappee Dashboard. Changing the authentication methods can be done remotely.
	Scan and charge and Swipe and charge (with Smappee CSMS) can only be used when a Smappee Payment Agreement has been signed. Please contact your Business Developer for more info.

### Plug and charge

The charging station is freely accessible without needing to authorize. Anyone can plug their car into the charger and start charging for free.

#### Start charging



#### Stop charging



## Swipe and charge

Charging sessions can be started using an RFID card. You can either use a Smappee Smart Charge Card for free charging or (if activated) a third party eMSP card to pay for charging sessions.

- **Free charging:** charging is free with your Smappee Smart Charge Card or any other authorized RFID card. Once the charging cable is plugged-in, the user simply swipes their RFID card and the free charging session begins. All authorized cards must first be added to the whitelist using the 'Whitelisting' card on [dashboard.smappee.net](https://dashboard.smappee.net). See [this](#) article for more information. Each EV Wall includes one free Smappee Smart Charge Card. Additional cards can be ordered via [info@smappee.com](mailto:info@smappee.com).
- **Public charging:** other EV drivers can use this charging station and pay with a payment card from a third-party eMSP such as Shell Recharge or Plugsurfing . This can be done through Smappee's own CSMS or through a third-party CSMS. In case you would like to use the Smappee CSMS, please contact [info@smappee.com](mailto:info@smappee.com) to activate this.

### Start charging



### Stop charging



## Scan and charge

The user pays by credit card (Visa or Mastercard) using the Smappee app. They scan the QR code shown on the charging station and the app will guide them through the process of starting the charging session. It is also possible to set discount rates for specific users. Please contact [info@smappee.com](mailto:info@smappee.com) to activate Scan and charge and request your QR code sticker.

### Start charging









### Stop charging



More information on how to use the Smappee EV Wall can be found on: [support.smappee.com/hc](https://support.smappee.com/hc) > Smappee EV Line

## LED status

LED colour	LED status	Meaning	Action of the user
	White continuous	The Smappee EV Wall is available.	Connect your EV with the Smappee EV Wall.
	Blue continuous	Your EV is connected with the Smappee EV Wall, but is not yet charging.	<ul style="list-style-type: none"> <li>• If using an RFID, scan your charge card and wait until the LED turns blue and flashes.</li> <li>• If using QR codes, scan the QR code and wait until the LED is green pulsing.</li> <li>• If no authorisation is required, wait until the LED becomes green pulsing.</li> </ul>
	Blue flashing	Your RFID card is being verified.	Wait until the LED is green pulsing.
	Green pulsing	The Smappee EV Wall is charging your EV.	Your EV is being charged.
	Green continuous	The EV is now fully charged.	Disconnect the cable.
	Red continuous	The Smappee EV Wall is unavailable.	Check the manual or contact your supplier for more info and further steps.
	Red flashing	Your charge card is not authorised.	Contact your charge card supplier.

## 9. Declaration of conformity

**We,**

smappee nv  
Evolis 104  
B-8500 Kortrijk  
Belgium

**following the provision of the following EC Directives:**

- 2014/35/EU The Low Voltage Directive
- 2014/30/EU The Electromagnetic Compatibility Directive
- 2011/65/EU RoHS Directive

**hereby declare that the product:**

EVW-132-BR-E-W, EVW-132-BR-E-B, EVW-132-C2R-E-W, EVW-132-C2R-E-B, EVW-132-C8R-E-W, EVW-132-C8R-E-B, EVW-332-BR-E-W, EVW-332-BR-E-B, EVW-332-C2R-E-W, EVW-332-C2R-E-B, EVW-332-C8R-E-W, EVW-332-C8R-E-B

**is in conformity with the applicable requirements of the following documents**

\* Emissions:

(EN61326-1 : 2013)

Radiated Emission: EN 55011:2009 / EN 55032:2015 (Class B)  
Conducted Emission: EN 55011:2009 / EN 55032:2015 (Class B)  
Harmonic current Emission: EN 61000-3-2:2005 + A1:2008 + A2:2009  
Flicker: EN 61000-3-3:2008

\* Immunity:

(EN61326-1 : 2013)

ESD : EN 61000-4-2:2008 / EN 61000-4-2 :2009  
Radiated immunity : EN 61000-4-3:2006 + A1:2007 + A2: 2010  
Power frequency magnetic field: EN 61000-4-8:2009  
Voltage dips/interruptions: EN 61000-4-11:2004  
Common Mode Immunity: EN 61000-4-6:2008 / EN 61000-4-6:2009  
Burst : EN 61000-4-4:2004 / EN 61000-4-4:2012  
Surge: EN 61000-4-5:2005 / EN 61000-4-5:2006

\* Safety:

Metering Function : IEC 61010-1 Ed 3.0 (2010-06) + A1:2016  
AC Charging equipment : IEC 61851-1 (2017) / EN61558-1

Authorized signatory



Stefan Grosjean  
CEO